



# 1700 Series

## Forged Body, Integral Bonnet Needle Valves

These affordable valves are suited for a wide variety of process control applications. Non-rotating stainless steel or replaceable PCTFE stem tips reduce galling. Dyna-Pak® packing below the stem threads prevents fugitive emissions.



### Typical Applications

- Cylinder valves
- Panel board instrumentation
- Pressure gauge valves
- Sampling systems
- Research laboratories
- Oxygen service
- Corrosive or high pressure service

### Technical Data

<b>BODY*</b>	316 stainless steel, Monel®
<b>MAXIMUM OPERATING PRESSURE</b>	6000 psig @ 70° F (414 Bar @ 21° C)
<b>OPERATING TEMPERATURE RANGE</b>	<i>Metal stem tip</i> -65° to +450° F (-54° to +232° C) <i>PCTFE stem tip</i> -20° to +250° F (-29° to +121° C)
<b>ORIFICE</b>	0.187" (4.8mm)
<b>Cv FACTOR</b>	0.31

\* Consult factory for other materials

### Features & Benefits

#### Safety

- Lock nut secures packing nut to prohibit accidental removal

#### Long cycle life

- Packing below stem threads prevents fluid from contacting the stem threads
- Non-rotating hardened 17-4PH stainless steel, Monel® or replaceable PCTFE stem tip is combined with a hardened 450 stainless steel - or Monel® thread gland to reduce galling

#### Helps eliminate fugitive emissions

- Dyna-Pak® packing provides a leak-tight seal with low operating torque

#### Reliability

- All valves are tested for bubble-tight leakage at both seat and packing

#### Installation variety

- Broad selection of male NPT, female NPT, and HOKE Gyrolok® fractional or metric tube fitting connections

#### Panel mounting

- Panel mounting is standard on all models
- Special High Tolerance NPT Thread

needle valves

### HOKE Incorporated

405 Centura Court • PO Box 4866 • Spartanburg, SC 29303  
Phone (864) 574-7966 Fax (864) 587-5608  
www.hoke.com • sales@hoke.com

# 1700 Series

## Materials of Construction

DESCRIPTION	316 STAINLESS STEEL	MONEL®
1 Body	316 stainless steel	Monel®
2 Stem	316 stainless steel	Monel®
<i>Stem tip</i>		
3 Soft	PCTFE	PCTFE
3 Hard	17-4PH stainless steel	Monel®
4 Stem packing	TFE/316 stainless steel wafers	TFE/Monel® wafers
5 Thread gland	450 stainless steel	Monel®
6 Lock nut	316 stainless steel	316 stainless steel
<i>Handle</i>		
7 1711 Series	Aluminum	Aluminum
7 1751 Series	ABS	ABS
8 Panel mounting nut	Nickel-plated brass	Nickel-plated brass

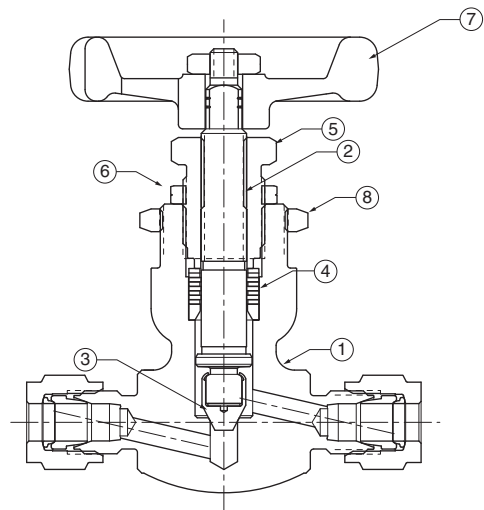

## Dimensions

### 1700 Series: Globe Pattern

INLET A	OUTLET B		D	E	F	H	H'
1/4" Gyrolok®	1/4" Gyrolok®	inch	3	2 1/6	2 1/2	1/2	1 1/6
		mm	76	52	54	13	27
1/4" male NPT	1/4" male NPT	inch	3	2 3/6	2 1/2	1/2	1 1/6
		mm	76	56	54	13	27
1/4" male NPT	1/4" female NPT	inch	3	2 1/2	2 1/2	1/2	1 1/6
		mm	76	54	54	13	27
1/4" female NPT	1/4" female NPT	inch	3	2 1/6	2 1/2	1/2	1 1/6
		mm	76	52	54	13	27
3/8" Gyrolok®	3/8" Gyrolok®	inch	3	2 1/2	2 1/2	1/2	1 1/6
		mm	76	54	54	13	27
8mm Gyrolok®	8mm Gyrolok®	inch	3	2 1/6	2 1/2	1/2	1 1/6
		mm	76	68	54	13	27

Dimensions for reference only, subject to change.

### Panel mounting dimensions

Panel hole = 5/16" (22.6 mm) diameter

Panel thickness = 1/4" (6.4 mm) maximum

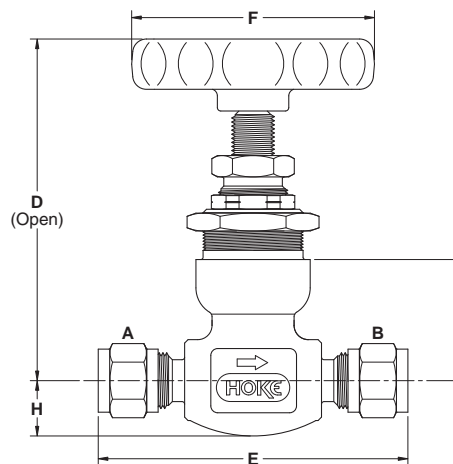

## Pressure vs. Temperature Curve

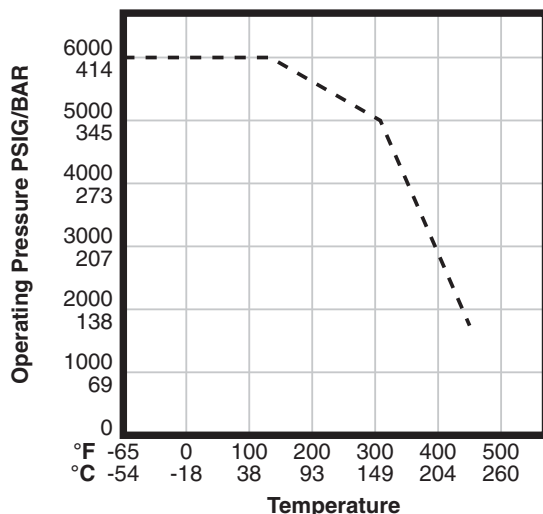

# 1700 Series

## Flow Curves

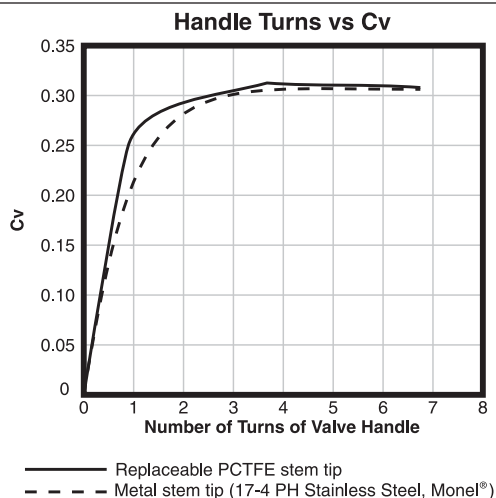

## How to Order: Standard Valves



1711L4Y: Globe pattern

### 1700 Series: Globe Pattern

Metal stem tip for service to +450° F (+232° C)

0.187" (4.7mm) orifice/0.31 Cv

END CONNECTIONS		ORDER BY PART NUMBER	
INLET	OUTLET	316 STAINLESS STEEL	MONEL®
¼" Gyrolok®	¼" Gyrolok®	1711G4Y	—
¼" male NPT	¼" male NPT	1711M4Y	1711M4M
¼" male NPT	¼" female NPT	1711L4Y	—
¼" female NPT	¼" female NPT	1711F4Y	1711F4M
⅜" Gyrolok®	⅜" Gyrolok®	1711G6Y	—
8mm Gyrolok®	8mm Gyrolok®	1711G8YMM	—



1751G4Y: Globe pattern

### 1700 Series: Globe Pattern

PCTFE stem tip for service to +250° F (+121° C)

0.187" (4.7mm) orifice/0.31 Cv

END CONNECTIONS		ORDER BY PART NUMBER	
INLET	OUTLET	316 STAINLESS STEEL	MONEL®
¼" Gyrolok®	¼" Gyrolok®	1751G4Y	—
¼" male NPT	¼" male NPT	1751M4Y	1751M4M
¼" male NPT	¼" female NPT	1751L4Y	—
¼" female NPT	¼" female NPT	1751F4Y	1751F4M
⅜" Gyrolok®	⅜" Gyrolok®	1751G6Y	—
8mm Gyrolok®	8mm Gyrolok®	1751G8YMM	—

## Ordering Options

### Spare Parts

Spare parts and repair kits are available for all needle valves. Please contact your distributor for specific information.

### Cleaning and Testing

When ordering, please specify if oxygen cleaning or helium leak testing is required.

### Additional Sizes

Additional sizes and options are available on special request. Please consult your local HOKE distributor.